

THE PROPERTY OF THE DRAWING IS ESTABLISHED BY LAW. IT IS FORBIDDEN TO PRODUCE OR SHOW IT TO THIRD PARTY, WITHOUT A WRITTEN AGREEMENT.

Item	Name	Q.ty
1	PKS.1414.20	1
2	R.5.SCH	2
3	V.TCE5x20	2

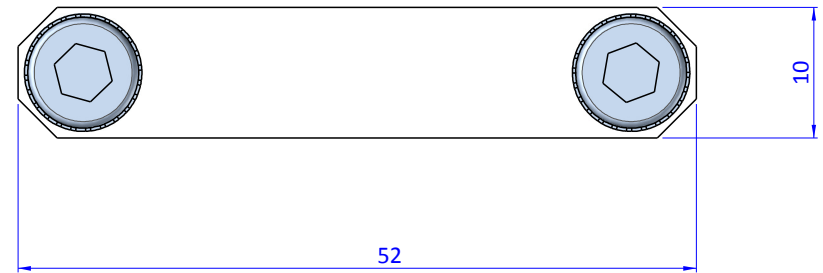
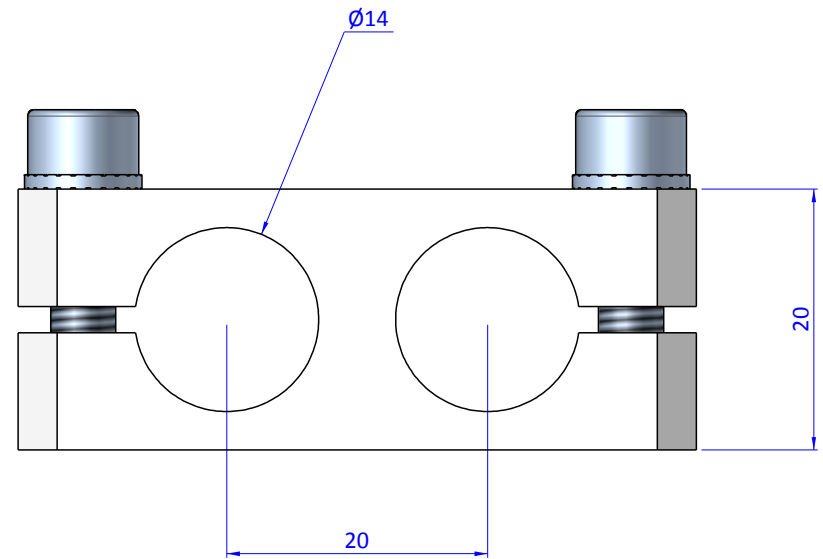
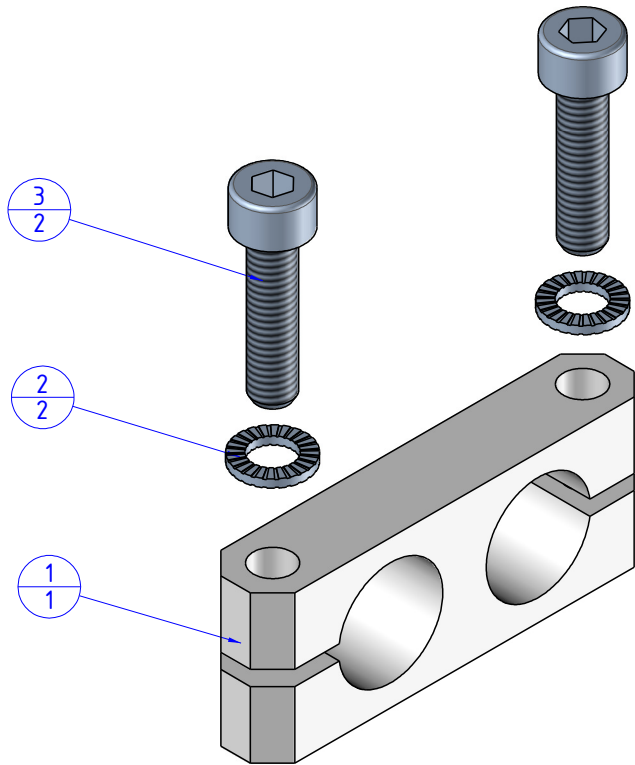

Format A3

UNI 936-76

FP SERVICES AUTOMATION		DESIGNED FROM FPSERVICES	REVIEW A
GENERAL TOLERANCE UNI - ISO 2768 CLASSE f	DESCRIPTION CA.PKS.1414.20	DATE 06/02/2019	WEIGHT 0,027kg
		CODE CA.PKS.1414.20	